

Dell™ Inspiron™

Quick Reference Guide

Model: DCMF

Notes, Notices, and Cautions



NOTE: A NOTE indicates important information that helps you make better use of your computer.



NOTICE: A NOTICE indicates either potential damage to hardware or loss of data and tells you how to avoid the problem.



CAUTION: A CAUTION indicates a potential for property damage, personal injury, or death.

Information in this document is subject to change without notice.

© 2008 Dell Inc. All rights reserved.

Reproduction of these materials in any manner whatsoever without the written permission of Dell Inc. is strictly forbidden.

Trademarks used in this text: *Dell*, the *DELL* logo, *DellConnect*, *Inspiron*, and *YOURS IS HERE* are trademarks of Dell Inc.; *Intel*, *Celeron*, *Core*, and *Pentium* are registered trademarks of Intel Corporation; *AMD*, *AMD Athlon*, and *Phenom* are trademarks of Advanced Micro Devices, Inc.; *HyperTransport* is a licensed trademark of the HyperTransport Technology Consortium; *Microsoft*, *Windows*, *Windows Vista*, and *Windows Vista start button* are either trademarks or registered trademarks of Microsoft Corporation in the United States and/or other countries; *Bluetooth* is a trademark owned by Bluetooth SIG, Inc. and is used by Dell Inc. under license; *Blu-ray Disc* is a trademark of Blu-ray Disc Association.

Other trademarks and trade names may be used in this document to refer to either the entities claiming the marks and names or their products. Dell Inc. disclaims any proprietary interest in trademarks and trade names other than its own.

Model: DCMF

June 2008

P/N MT480

Rev. A01

Contents

1	About Your Dell™ Inspiron™ 518/519	7
	Front View	7
	Back View	8
	Back Panel Connectors.	9
2	Setting Up Your Computer	11
	Installing Your Computer in an Enclosure.	11
	Connecting to the Internet.	13
	Setting Up Your Internet Connection.	13
	Transferring Information to a New Computer.	15
3	Specifications	17
4	Troubleshooting.	27
	Troubleshooting Tools.	27
	Beep Codes.	27
	System Messages	29
	Troubleshooting Hardware Problems in the Windows Vista® Operating System	31
	Dell Diagnostics	31

Solving Problems	35
Power Problems	35
Memory Problems	36
Lockups and Software Problems	37
5 Reinstalling Your Operating System	41
Drivers	41
What Is a Driver?	41
Identifying Drivers	42
Reinstalling Drivers and Utilities	42
Using the <i>Drivers and Utilities</i> media.	43
Restoring Your Operating System	44
Using Microsoft Windows System Restore.	45
Using Dell Factory Image Restore	46
Using the Operating System Media.	47
6 Finding Information	49
7 Getting Help	51
Obtaining Assistance	51
Technical Support and Customer Service	52
DellConnect™.	52
Online Services	52
AutoTech Service	53
Automated Order-Status Service	53
Problems With Your Order	53
Product Information	54

Returning Items for Warranty Repair or Credit	54
Before You Call	55
Contacting Dell	57
A Appendix	59
FCC Notice (U.S. Only)	59
FCC Class B	59
Macrovision Product Notice	60
Index	61

About Your Dell™ Inspiron™ 518/519

 **NOTE:** For more information about the ports and connectors on your computer, see "Specifications" on page 17.

Front View

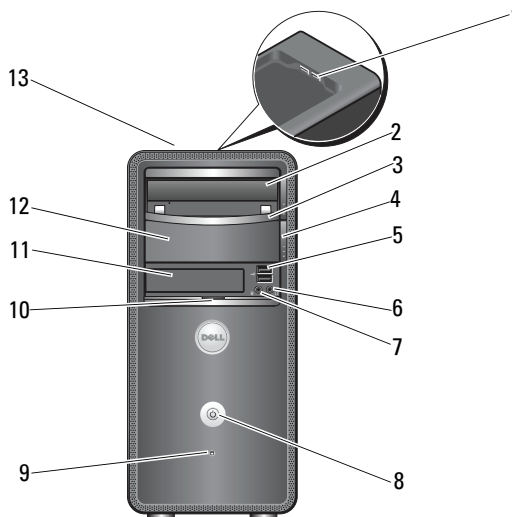

- | | | | |
|----|---|----|----------------------------|
| 1 | USB 2.0 connectors (2) | 2 | optical drive |
| 3 | optical-drive panel | 4 | optical-drive eject button |
| 5 | USB 2.0 connectors (2) | 6 | headphone connector |
| 7 | microphone connector | 8 | power button |
| 9 | drive activity light | 10 | front-panel door grip |
| 11 | FlexBay drive | 12 | optional optical-drive bay |
| 13 | Service Tag (located on top of the chassis towards the front) | | |

Back View

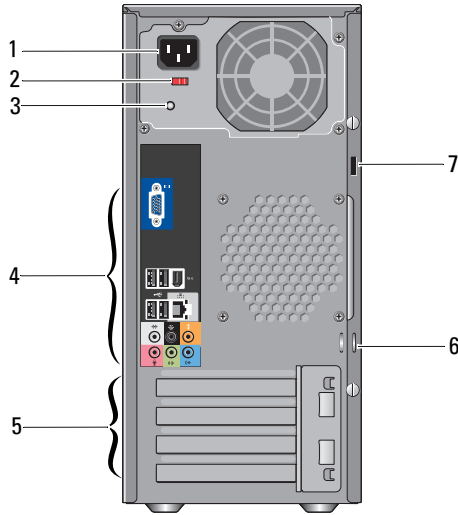

- | | | | |
|---|--------------------------|---|-------------------------|
| 1 | power connector | 2 | voltage selector switch |
| 3 | power supply light | 4 | back panel connectors |
| 5 | expansion card slots (4) | 6 | padlock rings |
| 7 | security cable slot | | |

Back Panel Connectors

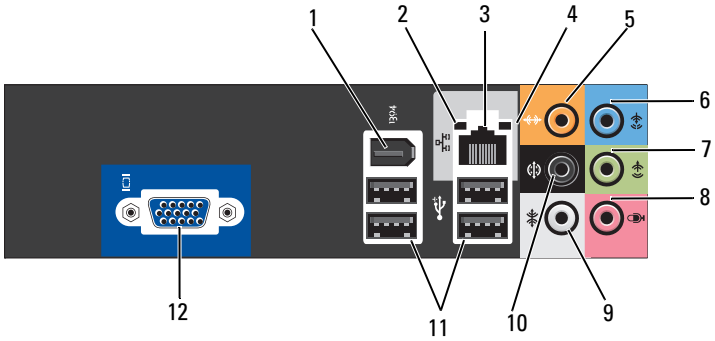

- | | | | |
|----|------------------------------|----|------------------------------|
| 1 | IEEE 1394 connector | 5 | center/subwoofer connector |
| 2 | link integrity light | 6 | line-in connector |
| 3 | network adapter connector | 7 | front L/R line-out connector |
| 4 | network activity light | 8 | microphone |
| 5 | center/subwoofer connector | 9 | side L/R surround connector |
| 6 | line-in connector | 10 | back L/R surround connector |
| 7 | front L/R line-out connector | 11 | USB 2.0 connectors (4) |
| 8 | microphone | 12 | VGA video connector |
| 9 | side L/R surround connector | | |
| 10 | back L/R surround connector | | |
| 11 | USB 2.0 connectors (4) | | |
| 12 | VGA video connector | | |

Setting Up Your Computer

Installing Your Computer in an Enclosure

Installing your computer in an enclosure can restrict the airflow and impact your computer's performance, possibly causing it to overheat. Follow the guidelines below when installing your computer in an enclosure:

- ➡ **NOTICE:** The operating temperature specifications indicated in this manual reflects the maximum ambient operating temperature. The room ambient temperature needs to be a consideration when installing your computer in an enclosure. For example, if the ambient room temperature is at 25°C (77°F), depending on your computer's specifications, you only have 5° to 10°C (9° to 18°F) temperature margin before you reach your computer's maximum operating temperature. For details about your computer's specifications, see "Specifications" on page 17.
- Leave a 10.2 cm (4 in) minimum clearance on all vented sides of the computer to permit the airflow required for proper ventilation.
- If your enclosure has doors, they need to be of a type that allows at least 30 percent airflow through the enclosure (front and back).
- ➡ **NOTICE:** Do not install your computer in an enclosure that does not allow airflow. Restricting the airflow impacts your computer's performance, possibly causing it to overheat.

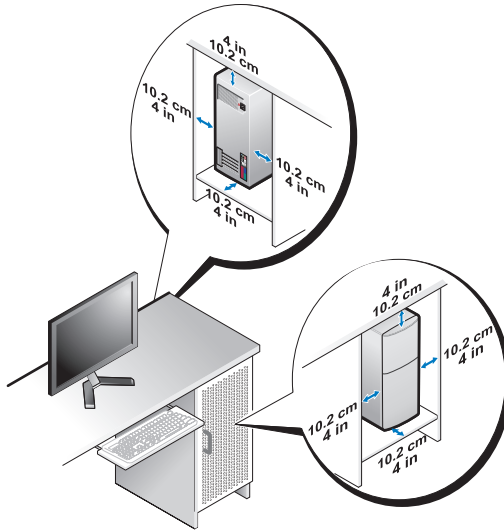

- If your computer is installed in a corner on a desk or under a desk, leave at least 5.1 cm (2 in) clearance from the back of the computer to the wall to permit the airflow required for proper ventilation.

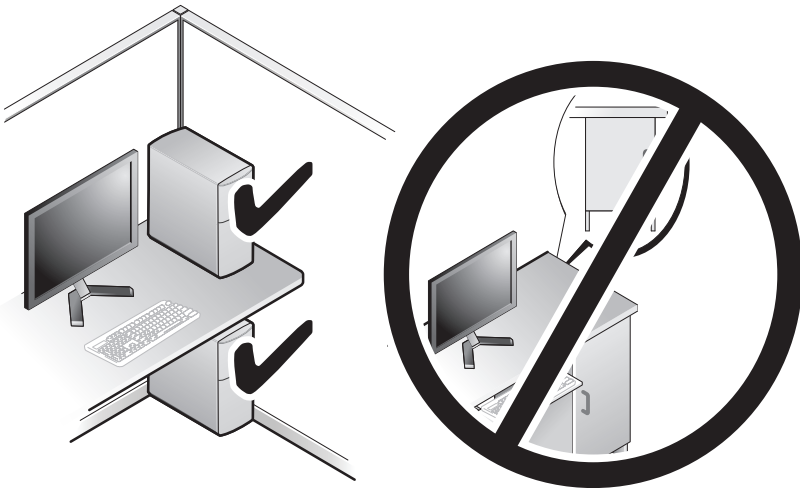

Connecting to the Internet

 **NOTE:** ISPs and ISP offerings vary by country.

To connect to the Internet, you need a modem or network connection and an Internet service provider (ISP). Your ISP will offer one or more of the following Internet connection options:

- DSL connections that provide high-speed Internet access through your existing telephone line or cellular telephone service. With a DSL connection, you can access the Internet and use your telephone on the same line simultaneously.
- Cable modem connections that provide high-speed Internet access through your local cable TV line.
- Satellite modem connections that provide high-speed Internet access through a satellite television system.
- Dial-up connections that provide Internet access through a telephone line. Dial-up connections are considerably slower than DSL and cable (or satellite) modem connections.
- Wireless LAN connections that provide Internet access using Bluetooth® wireless technology.

If you are using a dial-up connection, connect a telephone line to the modem connector on your computer and to the telephone wall jack before you set up your Internet connection. If you are using a DSL or cable/satellite modem connection, contact your ISP or cellular telephone service for setup instructions.

Setting Up Your Internet Connection

To set up an Internet connection with a provided ISP desktop shortcut:

- 1 Save and close any open files, and exit any open programs.
- 2 Double-click the ISP icon on the Microsoft® Windows® desktop.
- 3 Follow the instructions on the screen to complete the setup.

If you do not have an ISP icon on your desktop or if you want to set up an Internet connection with a different ISP, perform the steps in the following section that corresponds to the operating system your computer is using.

 **NOTE:** If you are having problems connecting to the Internet, see your *Dell Technology Guide*. If you cannot connect to the Internet but have successfully connected in the past, the ISP might have a service outage. Contact your ISP to check the service status, or try connecting again later.

 **NOTE:** Have your ISP information ready. If you do not have an ISP, the **Connect to the Internet** wizard can help you get one.

- 1 Save and close any open files, and exit any open programs.
- 2 Click the Windows Vista start button™ , and click **Control Panel**.
- 3 Under **Network and Internet**, click **Connect to the Internet**.
The **Connect to the Internet** window appears.
- 4 Click either **Broadband (PPPoE)** or **Dial-up**, depending on how you want to connect:
 - Choose **Broadband** if you will use a DSL, satellite modem, cable TV modem, or Bluetooth wireless technology connection.
 - Choose **Dial-up** if you will use a dial-up modem or ISDN.

 **NOTE:** If you do not know which type of connection to select, click **Help me choose** or contact your ISP.

- 5 Follow the instructions on the screen and use the setup information provided by your ISP to complete the setup.
- 6 Save and close any open files, and exit any open programs.
- 7 Click the Windows Vista start button , and click **Control Panel**.
- 8 Under **Network and Internet**, click **Connect to the Internet**.

The **Connect to the Internet** window appears.

- 9 Click either **Broadband (PPPoE)** or **Dial-up**, depending on how you want to connect:
 - Choose **Broadband** if you will use a DSL, satellite modem, cable TV modem, or Bluetooth wireless technology connection.
 - Choose **Dial-up** if you will use a dial-up modem or ISDN.
-  **NOTE:** If you do not know which type of connection to select, click **Help me choose** or contact your ISP.
- 10 Follow the instructions on the screen and use the setup information provided by your ISP to complete the setup.

Transferring Information to a New Computer

You can use your operating system "wizards" to help you transfer files and other data from one computer to another—for example, from an *old* computer to a *new* computer. To transfer information to a new computer using the Windows Vista[®] wizard:

- 1 Click the Windows Vista start button , and then click **Transfer files and settings**→**Start Windows Easy Transfer**.
- 2 In the **User Account Control** dialog box, click **Continue**.
- 3 Click **Start a new transfer** or **Continue a transfer in progress**.

Follow the instructions provided on the screen by the **Windows Easy Transfer** wizard.

Specifications



NOTE: Offerings may vary by region. For more information regarding the configuration of your computer, click **Start→Help and Support** and select the option to view information about your computer.

Processor	Inspiron 518	Inspiron 519
Type	<ul style="list-style-type: none"> • Intel® Core™ 2 Quad processor • Intel Core 2 Duo processor • Intel Pentium® Dual-Core processor • Intel Celeron® processor 	<ul style="list-style-type: none"> • AMD Athlon™ 64/ LE/ 64 X2/ X2 BE • AMD Phenom™ X2/ X4/ X2 GE/ triple core
L2 cache	At least 512 KB pipelined-burst, eight-way set associative, writeback SRAM	<ul style="list-style-type: none"> • Up to 2 MB for AMD Athlon 64 X2 dual-core processors • Up to 512 KB for AMD Athlon 64 processors • Up to 4 MB for AMD Phenom processors
DRAM bus width	Not applicable	64 bits per channel
Computer Information	Inspiron 518	Inspiron 519
System chipset	Intel G33 and ICH9	AMD RS780 and SB700
RAID support	RAID 1 (mirroring)	Not applicable
Data bus width	64 bits	Not applicable
DRAM bus width	64 bits	Not applicable
Processor address bus width	32 bits	16 bit up/down HyperTransport link
Flash EPROM	8 Mb	8 Mb

Expansion Bus	Inspiron 518	Inspiron 519	
Bus type	PCI 2.3	PCI 2.3	
	PCI Express 1.0A	PCI Express 2.0	
	SATA 1.0 and 2.0	SATA 1.0 and 2.0	
	USB 2.0	USB 2.0	
Bus speed			
PCI	133 MB/s	133 MB/s	
PCI Express	x1 slot bidirectional speed — 500 MB/s	x1 slot bidirectional speed —1 GB/s	
	x16 slot bidirectional speed — 8 GB/s	x16 slot bidirectional speed — 16 GB/s	
SATA	1.5 Gbps and 3.0 Gbps	1.5 Gbps and 3.0 Gbps	
USB	<ul style="list-style-type: none"> • High speed — 480 Mbps • Full speed — 12 Mbps • Low speed — 1.2 Mbps 	<ul style="list-style-type: none"> • High speed — 480 Mbps • Full speed — 12 Mbps • Low speed — 1.2 Mbps 	
	PCI		
	Connectors	One	One
Connector size	124 pins	124 pins	
Connector data width (maximum)	32 bits	32 bits	
PCI Express			
Connector	Two x1	Two x1	
Connector size	36 pins	36 pins	
Connector data width (maximum)	1 PCI Express lane	1 PCI Express lane	
PCI Express			
Connector	One x16	One x16	
Connector size	164 pins	164 pins	
Connector data width (maximum)	16 PCI Express lane	16 PCI Express lane	

Memory	Inspiron 518/519
Memory module connector	Four user-accessible DDR2 DIMM sockets
Memory module capacities	512 MB, 1 GB, and 2 GB
Memory type	667 MHz, 800 MHz Non-ECC DDR2 SDRAM
Minimum memory	512 MB
Maximum memory	4 GB

Drives	Inspiron 518/519
Externally accessible	One 3.5-inch drive bay Two 5.25-inch drive bays
Internally accessible	Two 3.5-inch drive bays
Available devices	Two 3.5-inch SATA hard drives Two 5.25-inch SATA DVD-ROM/ DVD +/- RW super multi drive / Blu-ray Disc drive / Blu-ray Disc RW drive One 3.5-inch USB media card reader/Bluetooth media card reader

External connectors

Audio

ALC888 (7.1 Channel audio)

Line-in connector — Use the blue line-in connector to attach a record/playback device such as a microphone, cassette player, CD player, or VCR.

On computers with a sound card, use the connector on the card.

Front L/R line-out connector — Use the green line-out connector to attach headphones and most speakers with integrated amplifiers.

On computers with a sound card, use the connector on the card.

Microphone connector — Use the pink connector to attach a personal computer microphone for voice or musical input into a sound or telephony program.

On computers with a sound card, use the microphone connector on the card.

Center/sub-woofer connector — Use the orange connector to attach the sub-woofer.

Back L/R speakers connector — Use the black surround connector to attach multichannel-capable speakers.

Side L/R surround connector — Use the gray connector to provide enhanced surround audio for computers with 7.1 speakers.

On computers with a sound card, use the connector on the card.

IEEE 1394

One 6-pin serial connector on the back-panel

Use the IEEE 1394 connector for high-speed data devices such as digital video cameras and external storage devices.

Connectors (continued)

Inspiron 518/519

Network

10/100/1000 Mbps Ethernet LAN on the system board.

RJ-45 port — Connect one end of a network cable to either a network connector or your network or broadband device. Connect the other end of the network cable to the network adapter connector on your computer. A click indicates that the network cable has been securely attached.



NOTICE: Do not plug a telephone cable into the network connector.

On computers with an additional network connector card, use the connectors on the card and on the back of the computer when setting up multiple network connections (such as a separate intra- and extranet).

It is recommended that you use Category 5 wiring and connectors for your network. If you must use Category 3 wiring, force the network speed to 10 Mbps to ensure reliable operation.

USB

Eight USB 2.0-compliant connectors

Front-panel (2)

Back-panel (4)

Top USB tray (2)

Use the back USB connectors for devices that typically remain connected, such as printers and keyboards.

NOTE: It is recommended that you use the front USB connectors for devices that you connect occasionally, such as flash memory keys or cameras, or for bootable USB devices.

Connectors *(continued)***Inspiron 518/519**

Video	Integrated video 15-hole connector — Connect the monitor's VGA cable to the VGA connector on the computer. NOTE: Your computer supports an optional PCI Express x16 graphics card. If you have installed a graphics card, use the connector on the card.
System board connectors	
Chassis fan	One 3-pin connector
Front panel audio HDA header	One 10-pin connector
Front panel control	One 10-pin connector
Internal USB	Four 10-pin connectors
Memory	Four 240-pin connectors
PCI 2.3	One 124-pin connector
PCI Express x1	Two 36-pin connectors
PCI Express x16	One 164-pin connector
Power	One 24-pin connector
Power 12V	One 4-pin connector
Processor	<ul style="list-style-type: none">• Inspiron 518 — one 775-pin connector• Inspiron 519 — one 940-pin connector
Processor fan	One 4-pin connector
Serial ATA	Four 7-pin connectors

Controls and Lights

Inspiron 518/519

Front of the computer

Power button

Push button

Power light

Blue light — Blinking blue indicates that the computer is in sleep state; solid blue indicates power-on state.

Amber light — Blinking amber indicates a problem with the system board. A solid amber light when the system does not boot indicates that the system board cannot start initialization. This could be an issue with the system board or power supply (see "Power Problems" on page 35).

Drive activity light

Blue light — A blinking blue light indicates the computer is reading data from or writing data to the SATA hard drive or the optical drive.

Controls and Lights (continued)**Inspiron 518/519**

Back of the computer

Link integrity light (on integrated network adapter)

Green light — indicates a good connection exists between a 10/100-Mbps network and the computer.

Orange light — indicates a good connection exists between a 1000-Mbps network and the computer.

Off (no light) — indicates that the computer is not detecting a physical connection to the network.

Network activity light (on integrated network adapter)

Yellow blinking light — indicates that there is activity on the network.

Off (no light) — indicates that there is no activity on the network.

Power supply diagnostic light

Green — indicates that the power supply is receiving power.

Off — indicates that the power supply is not receiving power or the power supply is not working.

Power**Inspiron 518/519**

DC power supply:

Wattage

300 W

Maximum heat dissipation

162 W

NOTE: Heat dissipation is calculated by using the power supply wattage rating.

Voltage (see the safety instructions that shipped with your computer for important voltage setting information)

115/230 VAC, 50/60 Hz, and 7A/ 4A

Coin cell battery

3-V CR2032 lithium coin cell

Physical	Inspiron 518/519
Height	379 mm (14.9 inches)
Width	17.0 cm (6.7 inches)
Depth	43.5 cm (17.1 inches)
Weight	13.1 kg (28.9 lb)
Environmental	Inspiron 518/519
Temperature range:	
Operating	10° to 35°C (50° to 95°F)
Storage	-40° to 65°C (-40° to 149°F)
Relative humidity (maximum):	20% to 80% (noncondensing)
Maximum vibration (using a random-vibration spectrum that simulates user environment):	
Operating	5 to 350 Hz at 0.0002 G2/Hz
Storage	5 to 500 Hz at 0.001 to 0.01 G2/Hz
Maximum shock (measured with hard drive in head-parked position and a 2-ms half-sine pulse):	
Operating	40 G +/- 5% with pulse duration of 2 msec +/- 10% (equivalent to 20 in/sec [51 cm/sec])
Storage	105 G +/- 5% with pulse duration of 2 msec +/- 10% (equivalent to 50 in/sec [127 cm/sec])
Altitude (maximum):	
Operating	-15.2 to 3048 m (-50 to 10,000 ft)
Storage	-15.2 to 10,668 m (-50 to 35,000 ft)
Airborne contaminant level	G2 or lower as defined by ISA-S71.04-1985

Troubleshooting



CAUTION: To guard against likelihood of electric shock, laceration by moving fan blades or other unexpected injuries, always unplug your computer from the electrical outlet before opening the cover.

Troubleshooting Tools

Follow these tips when troubleshooting your computer:

- If you added or removed a part before the problem started, review the installation procedures and ensure that the part is correctly installed.
- If a peripheral device does not work, ensure that the device is properly connected.
- If an error message appears on the screen, write down the exact message. This message may help support personnel diagnose and fix the problem(s).
- If an error message occurs in a program, see the program's documentation.



NOTE: The procedures in this document were written for the Microsoft® Windows® default view, so these may not apply if you set your Dell™ computer to the Windows Classic view.

Beep Codes

Your computer might emit a series of beeps during start-up if the monitor cannot display errors or problems. This series of beeps, called a beep code, identifies a problem. One possible beep code consists of repetitive three short beeps. This beep code tells you that the computer encountered a possible system board failure.

If your computer beeps during start-up:

- 1 Write down the beep code.
- 2 Run the Dell Diagnostics to identify a more serious cause (see "Dell Diagnostics" on page 31).

Code (repetitive short beeps)	Description	Suggested Remedy
1	BIOS checksum failure. Possible system board failure.	Contact Dell. For more information, see "Contacting Dell" on page 57.
2	No memory modules are detected	<p>1 If you have two or more memory modules installed, remove the modules, reinstall one module (see the <i>Service Manual</i> on the Dell Support website at support.dell.com), and then restart the computer. If the computer starts normally, reinstall an additional module. Continue until you have identified a faulty module or reinstalled all modules without error.</p> <p>2 If available, install good memory of the same type into your computer (see the <i>Service Manual</i> on the Dell Support website at support.dell.com).</p> <p>3 If the problem persists, contact Dell.</p>
3	Possible system board failure	Contact Dell. For more information, see "Contacting Dell" on page 57.
4	RAM Read/Write failure	<p>1 Ensure that no special memory module/memory connector placement requirements exist (see the <i>Service Manual</i> on the Dell Support website at support.dell.com).</p> <p>2 Verify that the memory modules that you are installing are compatible with your computer (see the <i>Service Manual</i> on the Dell Support website at support.dell.com).</p> <p>3 If the problem persists, contact Dell (see "Contacting Dell" on page 57).</p>
5	Real time clock failure. Possible battery failure or system board failure.	<p>1 Replace the battery (see the <i>Service Manual</i> on the Dell Support website at support.dell.com).</p> <p>2 If the problem persists, contact Dell (see "Contacting Dell" on page 57).</p>

Code (repetitive short beeps)	Description	Suggested Remedy
6	Video BIOS Test Failure	Contact Dell. For more information, see "Contacting Dell" on page 57.
7	CPU cache test failure	Contact Dell. For more information, see "Contacting Dell" on page 57.

System Messages



NOTE: If the message you received is not listed in the table, see the documentation for either the operating system or the program that was running when the message appeared.



NOTE: For information on removing and installing parts, see the *Service Manual* on the Dell Support website at support.dell.com.

1394 CABLE CONNECTION FAILURE — The IEEE 1394 cable may be loose. Check for loose cable connection.

ALERT! PREVIOUS ATTEMPTS AT BOOTING THIS SYSTEM HAVE FAILED AT CHECKPOINT [NNNN]. FOR HELP IN RESOLVING THIS PROBLEM, PLEASE NOTE THIS CHECKPOINT AND CONTACT DELL TECHNICAL SUPPORT — The computer failed to complete the boot routine three consecutive times for the same error (see "Contacting Dell" on page 57 for assistance).

CMOS CHECKSUM ERROR — Possible system board failure or RTC battery low. Replace battery. See the *Service Manual* on the Dell Support website at support.dell.com or see "Contacting Dell" on page 57 for assistance.

CPU FAN FAILURE — CPU fan failure. Replace CPU fan.

DISKETTE READ FAILURE — The floppy disk may be defective or a cable may be loose. Replace floppy disk or check for loose cable connection.

FRONT I/O CABLE CONNECTION FAILURE — The front I/O panel cable may be loose.

FRONT USB CABLE CONNECTION FAILURE — The USB cable that connects the USB ports on the front I/O panel to the system board may be loose.

HARD-DISK DRIVE FAILURE — Possible hard disk drive failure during hard drive power-on self-test (POST). Check cables /swap hard disks or see "Contacting Dell" on page 57 for assistance.

HARD-DISK DRIVE READ FAILURE — Possible hard drive failure during hard drive boot test (see "Contacting Dell" on page 57 for assistance).

KEYBOARD FAILURE — Keyboard failure or keyboard cable loose.

NO BOOT DEVICE AVAILABLE — No bootable partition on hard drive or no bootable media in the optical drive, or hard drive/optical drive cable is loose, or no bootable device exists.

- If the optical drive is your boot device, ensure that a bootable media is in the drive.
- If the hard drive is your boot device, ensure that the cables are connected and that the drive is installed properly and partitioned as a boot device.
- Enter system setup and ensure that the boot sequence information is correct.

NO TIMER TICK INTERRUPT — A chip on the system board might be malfunctioning or system board failure.

NOTICE - HARD DRIVE SELF MONITORING SYSTEM HAS REPORTED THAT A PARAMETER HAS EXCEEDED ITS NORMAL OPERATING RANGE. DELL RECOMMENDS THAT YOU BACK UP YOUR DATA REGULARLY. A PARAMETER OUT OF RANGE MAY OR MAY NOT INDICATE A POTENTIAL HARD DRIVE PROBLEM. —

Self monitoring, analysis, and reporting technology (S.M.A.R.T.) error. Possible hard drive failure. This feature can be enabled or disabled in basic input/output system (BIOS) setup.

TOP USB CABLE CONNECTION FAILURE — The USB cable that connects the USB ports on the top USB tray to the system board may be loose.

USB OVER CURRENT ERROR — Disconnect the USB device. Use external power source for the USB device.

WARNING: SYSTEM FAN FAILURE, PLEASE CONTACT DELL TECHNICAL SUPPORT IMMEDIATELY — System fan failure. Replace system fan.

Troubleshooting Hardware Problems in the Windows Vista® Operating System

If a device is either not detected during the operating system setup or is detected but incorrectly configured, you can use the Hardware Troubleshooter to resolve the incompatibility.

To start the Hardware Troubleshooter:

- 1 Click the Windows Vista start button , and click **Help and Support**.
- 2 Type `hardware troubleshooter` in the search field and press <Enter> to start the search.

In the search results, select the option that best describes the problem and follow the remaining troubleshooting steps.

Dell Diagnostics



CAUTION: Before you begin any of the procedures in this section, follow the safety instructions that shipped with your computer.

When to Use the Dell Diagnostics

If you experience a problem with your computer, perform the checks in Lockups and Software Problems (see "Lockups and Software Problems" on page 37) and run the Dell Diagnostics before you contact Dell for technical assistance.

It is recommended that you print these procedures before you begin.



NOTICE: The Dell Diagnostics works only on Dell™ computers.



NOTE: The *Drivers and Utilities* media is optional and may not ship with your computer.

See the *System Setup* section in the *Service Manual* to review your computer's configuration information, and ensure that the device that you want to test displays in the system setup program and is active.

Start the Dell Diagnostics from your hard drive or from the *Drivers and Utilities* media.

Starting the Dell Diagnostics From Your Hard Drive

The Dell Diagnostics is located on a hidden diagnostic utility partition on your hard drive.



NOTE: If your computer cannot display a screen image, see "Contacting Dell" on page 57.

- 1 Ensure that the computer is connected to an electrical outlet that is known to be working properly.
- 2 Turn on (or restart) your computer.
- 3 When the DELL™ logo appears, press <F12> immediately. Select **Diagnostics** from the boot menu and press <Enter>.



NOTE: If you wait too long and the operating system logo appears, continue to wait until you see the Microsoft® Windows® desktop; then, shut down your computer and try again.



NOTE: If you see a message stating that no diagnostics utility partition has been found, run the Dell Diagnostics from the *Drivers and Utilities* media.

- 4 Press any key to start the Dell Diagnostics from the diagnostics utility partition on your hard drive.

Starting the Dell Diagnostics From the *Drivers and Utilities* Media

- 1 Insert the *Drivers and Utilities* media.
- 2 Shut down and restart the computer.

When the DELL logo appears, press <F12> immediately.



NOTE: If you wait too long and the operating system logo appears, continue to wait until you see the Microsoft® Windows® desktop; then, shut down your computer and try again.



NOTE: The next steps change the boot sequence for one time only. On the next start-up, the computer boots according to the devices specified in the system setup program.

- 3 When the boot device list appears, highlight **CD/DVD/CD-RW** and press <Enter>.
- 4 Select the **Boot from CD-ROM** option from the menu that appears and press <Enter>.
- 5 Type 1 to start the CD menu and press <Enter> to proceed.

- 6 Select **Run the 32 Bit Dell Diagnostics** from the numbered list.
If multiple versions are listed, select the version appropriate for your computer.
- 7 When the Dell Diagnostics **Main Menu** appears, select the test you want to run.

Dell Diagnostics Main Menu

- 1 After the Dell Diagnostics loads and the **Main Menu** screen appears, click the button for the option you want.



NOTE: It is recommended that you select **Test System** to run a complete test on your computer.

Option	Function
Test Memory	Run the stand-alone memory test
Test System	Run System Diagnostics
Exit	Exit the Diagnostics

- 2 After you have selected the **Test System** option from the main menu, the following menu appears:



NOTE: It is recommended that you select **Extended Test** from the menu below to run a more thorough check of devices in the computer.

Option	Function
Express Test	Performs a quick test of devices in the system. This typically can take 10 to 20 minutes.
Extended Test	Performs a thorough check of devices in the system. This typically can take an hour or more.
Custom Test	Use to test a specific device or customize the tests to be run.
Symptom Tree	This option allows you to select tests based on a symptom of the problem you are having. This option lists the most common symptoms.

- 3 If a problem is encountered during a test, a message appears with an error code and a description of the problem. Write down the error code and problem description and see "Contacting Dell" on page 57.



NOTE: The Service Tag for your computer is located at the top of each test screen. If you contact Dell, technical support will ask for your Service Tag.

- 4 If you run a test from the **Custom Test or Symptom Tree** option, click the applicable tab described in the following table for more information.

Tab	Function
Results	Displays the results of the test and any error conditions encountered.
Errors	Displays error conditions encountered, error codes, and the problem description.
Help	Describes the test and may indicate requirements for running the test.
Configuration	Displays your hardware configuration for the selected device. The Dell Diagnostics obtains configuration information for all devices from system setup, memory, and various internal tests, and it displays the information in the device list in the left pane of the screen. The device list may not display the names of all the components installed on your computer or all devices attached to your computer.
Parameters	Allows you to customize the test by changing the test settings.

- 5 When the tests are complete, close the test screen to return to the **Main Menu** screen. To exit the Dell Diagnostics and restart the computer, close the **Main Menu** screen.
- 6 Remove the *Drivers and Utilities* media (if applicable).

Solving Problems

Power Problems



CAUTION: Before you begin any of the procedures in this section, follow the safety instructions that shipped with your computer.

IF THE POWER LIGHT IS OFF — The computer is either turned off or is not receiving power.

- Reseat the power cable into both the power connector on the back of the computer and the electrical outlet.
- If the computer is plugged into a power strip, ensure that the power strip is plugged into an electrical outlet and that the power strip is turned on. Also bypass power protection devices, power strips, and power extension cables to verify that the computer turns on properly.
- Ensure that the electrical outlet is working by testing it with another device, such as a lamp.

IF THE POWER LIGHT IS STEADY BLUE OR WHITE AND THE COMPUTER IS NOT RESPONDING —

- Ensure that the display is connected and powered on.
- If the display is connected and powered on, see "Beep Codes" on page 27.

IF THE POWER LIGHT IS BLINKING BLUE OR WHITE — The computer is in standby mode. Press a key on the keyboard, move the mouse, or press the power button to resume normal operation.

IF THE POWER LIGHT IS STEADY AMBER — Power problem or internal device malfunction.

- Ensure that the 12-volt power connector (12V) is securely connected to the system board (see the *Service Manual* on the Dell Support website at support.dell.com).
- Ensure that the main power cable and front panel cable are securely connected to the system board (see the *Service Manual* on the Dell Support website at support.dell.com).

IF THE POWER LIGHT IS BLINKING AMBER — The computer is receiving electrical power, a device might be malfunctioning or incorrectly installed.

- Remove and then reinstall the memory modules (see the *Service Manual* on the Dell Support website at support.dell.com).
- Remove and then reinstall any cards (see the *Service Manual* on the Dell Support website at support.dell.com).
- Remove and then reinstall the graphics card, if applicable (see the *Service Manual* on the Dell Support website at support.dell.com).

ELIMINATE INTERFERENCE — Some possible causes of interference are:

- Power, keyboard, and mouse extension cables.
- Too many devices on a power strip.
- Multiple power strips connected to the same electrical outlet.

Memory Problems



CAUTION: Before you begin any of the procedures in this section, follow the safety instructions that shipped with your computer.

IF YOU RECEIVE AN INSUFFICIENT MEMORY MESSAGE —

- Save and close any open files and exit any open programs you are not using to see if that resolves the problem.
- See the software documentation for minimum memory requirements. If necessary, install additional memory (See the *Service Manual* on the Dell Support website at support.dell.com).
- Reseat the memory modules (See the *Service Manual* on the Dell Support website at support.dell.com) to ensure that your computer is successfully communicating with the memory.
- Run the Dell Diagnostics (see "Dell Diagnostics" on page 31).

IF YOU EXPERIENCE OTHER MEMORY PROBLEMS —

- Reseat the memory modules (see the *Service Manual* on the Dell Support website at support.dell.com) to ensure that your computer is successfully communicating with the memory.
- Ensure that you are following the memory installation guidelines (see the *Service Manual* on the Dell Support website at support.dell.com).
- Your computer supports DDR2 memory. For more information about the type of memory supported by your computer, see "Specifications" on page 17.
- Run the Dell Diagnostics (see "Dell Diagnostics" on page 31).

Lockups and Software Problems



CAUTION: Before you begin any of the procedures in this section, follow the safety instructions that shipped with your computer.

The computer does not start up

Ensure that the power cable is firmly connected to the computer and to the electrical outlet.

The computer stops responding



NOTICE: You might lose data if you are unable to perform an operating system shutdown.

TURN THE COMPUTER OFF — If you are unable to get a response by pressing a key on your keyboard or moving your mouse, press and hold the power button for at least 8 to 10 seconds until the computer turns off. Then restart your computer.

A program stops responding

END THE PROGRAM —

- 1 Press <Ctrl><Shift><Esc> simultaneously.
- 2 Click Applications.
- 3 Click the program that is no longer responding.
- 4 Click End Task.

A program crashes repeatedly



NOTE: Software usually includes installation instructions in its documentation or on a floppy disk or CD.

CHECK THE SOFTWARE DOCUMENTATION — If necessary, uninstall and then reinstall the program.

A program is designed for an earlier Microsoft® Windows® operating system

RUN THE PROGRAM COMPATIBILITY WIZARD —

The Program Compatibility Wizard configures a program so that it runs in an environment similar to non-Windows Vista operating system environments.

- 1 Click Start  → Control Panel → Programs → Use an older program with this version of Windows.
- 2 In the welcome screen, click Next.
- 3 Follow the instructions on the screen.

A solid blue screen appears

TURN THE COMPUTER OFF — If you are unable to get a response by pressing a key on your keyboard or moving your mouse, press and hold the power button for at least 8 to 10 seconds until the computer turns off. Then restart your computer.

Other software problems

CHECK THE SOFTWARE DOCUMENTATION OR CONTACT THE SOFTWARE MANUFACTURER FOR TROUBLESHOOTING INFORMATION —

- Ensure that the program is compatible with the operating system installed on your computer.
- Ensure that your computer meets the minimum hardware requirements needed to run the software. See the software documentation for information.
- Ensure that the program is installed and configured properly.
- Verify that the device drivers do not conflict with the program.
- If necessary, uninstall and then reinstall the program.

BACK UP YOUR FILES IMMEDIATELY

USE A VIRUS-SCANNING PROGRAM TO CHECK THE HARD DRIVE, FLOPPY DISKS, OR CDs

SAVE AND CLOSE ANY OPEN FILES OR PROGRAMS AND SHUT DOWN YOUR COMPUTER THROUGH THE START MENU

Reinstalling Your Operating System

Drivers

What Is a Driver?

A driver is a program that controls a device such as a printer, mouse, or keyboard. All devices require a driver program.

A driver acts like a translator between the device and any other programs that use the device. Each device has its own set of specialized commands that only its driver recognizes.

Dell™ ships your computer to you with required drivers already installed—no further installation or configuration is needed.



NOTICE: The *Drivers and Utilities* media may contain drivers for operating systems that are not on your computer. Ensure that you are installing software appropriate for your operating system.

Many drivers, such as the keyboard driver, come with your Microsoft® Windows® operating system. You may need to install drivers if you:

- Upgrade your operating system.
- Reinstall your operating system.
- Connect or install a new device.

Identifying Drivers

If you experience a problem with any device, identify whether the driver is the source of your problem and, if necessary, update the driver.

- 1 Click the Windows Vista start button , and right-click **Computer**.
- 2 Click **Properties**→**Device Manager**.



NOTE: The **User Account Control** window may appear. If you are an administrator on the computer, click **Continue**; otherwise, contact your administrator to continue.

Scroll down the list to see if any device has an exclamation point (a yellow circle with a [!]) on the device icon.

If an exclamation point is next to the device name, you may need to reinstall the driver or install a new driver (see "Reinstalling Drivers and Utilities" on page 42).

Reinstalling Drivers and Utilities



NOTICE: The Dell Support website at support.dell.com and your *Drivers and Utilities* media provide approved drivers for Dell™ computers. If you install drivers obtained from other sources, your computer might not work correctly.

Using Windows Device Driver Rollback

If a problem occurs on your computer after you install or update a driver, use Windows Device Driver Rollback to replace the driver with the previously installed version.

- 1 Click the Windows Vista start button , and right-click **Computer**.
- 2 Click **Properties**→**Device Manager**.



NOTE: The **User Account Control** window may appear. If you are an administrator on the computer, click **Continue**; otherwise, contact your administrator to enter the Device Manager.

- 3 Right-click the device for which the new driver was installed and click **Properties**.
- 4 Click the **Drivers** tab→**Roll Back Driver**.

Using the *Drivers and Utilities* media

If using Device Driver Rollback or System Restore ("Restoring Your Operating System" on page 44) does not resolve the problem, then reinstall the driver from the *Drivers and Utilities* media.

- 1 With the Windows desktop displayed, insert the *Drivers and Utilities* media. If this is your first time to use the *Drivers and Utilities* media, go to step 2. If not, go to step 5.
- 2 When the *Drivers and Utilities* media installation program starts, follow the prompts on the screen.
- 3 When the **InstallShield Wizard Complete** window appears, remove the *Drivers and Utilities* media and click **Finish** to restart the computer.
- 4 When you see the Windows desktop, reinsert the *Drivers and Utilities* media.
- 5 At the **Welcome Dell System Owner** screen, click **Next**.



NOTE: The *Drivers and Utilities* media displays drivers only for hardware that came installed in your computer. If you installed additional hardware, the drivers for the new hardware might not be displayed by the *Drivers and Utilities* media. If those drivers are not displayed, exit the *Drivers and Utilities* media program. For drivers information, see the documentation that came with the device.

A message appears, stating that the *Drivers and Utilities* media is detecting hardware in your computer.



The drivers that are used by your computer are automatically displayed in the **My Drivers—The Drivers and Utilities media has identified these components in your system** window.

- 6 Click the driver that you want to reinstall and follow the instructions on the screen.

If a particular driver is not listed, that driver is not required by your operating system.

Manually Reinstalling Drivers

After extracting the driver files to your hard drive as described in the previous section:

- 1 Click the Windows Vista start button , and right-click **Computer**.
- 2 Click **Properties**→**Device Manager**.
 **NOTE:** The **User Account Control** window may appear. If you are an administrator on the computer, click **Continue**; otherwise, contact your administrator to enter the **Device Manager**.
- 3 Double-click the type of device for which you are installing the driver (for example, **Audio** or **Video**).
- 4 Double-click the name of the device for which you are installing the driver.
- 5 Click the **Driver** tab→**Update Driver**→**Browse my computer for driver software**.
- 6 Click **Browse** and browse to the location to which you previously copied the driver files.
- 7 When the name of the appropriate driver appears, click the name of the driver→**OK**→**Next**.
- 8 Click **Finish** and restart your computer.

Restoring Your Operating System

You can restore your operating system in the following ways:

- System Restore returns your computer to an earlier operating state without affecting data files. Use System Restore as the first solution for restoring your operating system and preserving data files.
- Dell Factory Image Restore returns your hard drive to the operating state it was in when you purchased the computer. Both permanently delete all data on the hard drive and remove any programs installed after you received the computer. Use Dell Factory Image Restore only if System Restore did not resolve your operating system problem.
- If you received an *Operating System* disc with your computer, you can use it to restore your operating system. However, using the *Operating System* disc also deletes all data on the hard drive. Use the disc *only* if System Restore did not resolve your operating system problem.



Using Microsoft Windows System Restore

The Windows operating systems provide a System Restore option which allows you to return your computer to an earlier operating state (without affecting data files) if changes to the hardware, software, or other system settings have left the computer in an undesirable operating state. Any changes that System Restore makes to your computer are completely reversible.

 **NOTICE:** Make regular backups of your data files. System Restore does not monitor your data files or recover them.

 **NOTE:** The procedures in this document were written for the Windows default view, so they may not apply if you set your Dell™ computer to the Windows Classic view.

Starting System Restore

- 1 Click Start .
- 2 In the Start Search box, type `System Restore` and press <Enter>.
 **NOTE:** The **User Account Control** window may appear. If you are an administrator on the computer, click **Continue**; otherwise, contact your administrator to continue the desired action.
- 3 Click **Next** and follow the remaining prompts on the screen.

In the event that System Restore did not resolve the issue, you may undo the last system restore.

Undoing the Last System Restore

 **NOTICE:** Before you undo the last system restore, save and close all open files and exit any open programs. Do not alter, open, or delete any files or programs until the system restoration is complete.

- 1 Click Start .
- 2 In the Start Search box, type `System Restore` and press <Enter>.
- 3 Click **Undo my last restoration** and click **Next**.

Using Dell Factory Image Restore

 **NOTICE:** Using Dell Factory Image Restore permanently deletes all data on the hard drive and removes any programs or drivers installed after you received your computer. If possible, back up the data before using these options. Use Dell Factory Image Restore only if System Restore did not resolve your operating system problem.

 **NOTE:** Dell Factory Image Restore may not be available in certain countries or on certain computers.

Use Dell Factory Image Restore only as the last method to restore your operating system. These options restore your hard drive to the operating state it was in when you purchased the computer. Any programs or files added since you received your computer—including data files—are permanently deleted from the hard drive. Data files include documents, spreadsheets, e-mail messages, digital photos, music files, and so on. If possible, back up all data before using Factory Image Restore.

Dell Factory Image Restore

- 1 Turn on the computer. When the Dell logo appears, press <F8> several times to access the Vista Advanced Boot Options Window.
- 2 Select **Repair Your Computer**.
The System Recovery Options window appears.
- 3 Select a keyboard layout and click **Next**.
- 4 To access the recovery options, log on as a local user. To access the command prompt, type `administrator` in the User name field, then click **OK**.
- 5 Click **Dell Factory Image Restore**.

 **NOTE:** Depending upon your configuration, you may need to select **Dell Factory Tools**, then **Dell Factory Image Restore**.

The Dell Factory Image Restore welcome screen appears.

- 6 Click **Next**.
The Confirm Data Deletion screen appears.

 **NOTICE:** If you do not want to proceed with Factory Image Restore, click **Cancel**.

- 7 Click the checkbox to confirm that you want to continue reformatting the hard drive and restoring the system software to the factory condition, then click **Next**.

The restore process begins and may take five or more minutes to complete. A message appears when the operating system and factory-installed applications have been restored to factory condition.

- 8 Click **Finish** to reboot the system.

Using the Operating System Media

Before you Begin

If you are considering reinstalling the Windows operating system to correct a problem with a newly installed driver, first try using Windows Device Driver Rollback. See "Using Windows Device Driver Rollback" on page 42. If Device Driver Rollback does not resolve the problem, then use System Restore to return your operating system to the operating state it was in before you installed the new device driver. See "Using Microsoft Windows System Restore" on page 45.



NOTICE: Before performing the installation, back up all data files on your primary hard drive. For conventional hard drive configurations, the primary hard drive is the first drive detected by the computer.

To reinstall Windows, you need the following items:

- Dell™ *Operating System* media
- Dell *Drivers and Utilities* media



NOTE: The Dell *Drivers and Utilities* media contains drivers that were installed during the assembly of the computer. Use the Dell *Drivers and Utilities* media to load any required drivers. Depending on the region from which you ordered your computer, or whether you requested the media, the Dell *Drivers and Utilities* media and *Operating System* media may not ship with your computer.

Reinstalling Windows Vista®

The reinstallation process can take 1 to 2 hours to complete. After you reinstall the operating system, you must also reinstall the device drivers, virus protection program, and other software.

- 1 Save and close any open files and exit any open programs.
- 2 Insert the *Operating System* media.
- 3 Click **Exit** if the **Install Windows** message appears.
- 4 Restart the computer.

When the DELL logo appears, press <F12> immediately.



NOTE: If you wait too long and the operating system logo appears, continue to wait until you see the Microsoft® Windows® desktop; then, shut down your computer and try again.



NOTE: The next steps change the boot sequence for one time only. On the next start-up, the computer boots according to the devices specified in the system setup program.

- 5 When the boot device list appears, highlight **CD/DVD/CD-RW Drive** and press <Enter>.
- 6 Press any key to **Boot from CD-ROM**.
- 7 Follow the instructions on the screen to complete the installation.

Finding Information



NOTE: Some features or media may be optional and may not ship with your computer. Some features or media may not be available in certain countries.



NOTE: Additional information may ship with your computer.

Document/Media/Label	Contents
<p>Service Tag/Express Service Code</p> <p>The Service Tag/Express Service Code is located on your computer.</p>	<ul style="list-style-type: none"> • Use the Service Tag to identify your computer when you use support.dell.com or contact support. • Enter the Express Service Code to direct your call when contacting support. <p>NOTE: Your Service Tag/Express Service Code is located on your computer.</p>
<p>Drivers and Utilities Media</p> <p>The <i>Drivers and Utilities</i> media is a CD or DVD that may have shipped with your computer.</p>	<ul style="list-style-type: none"> • A diagnostic program for your computer. • Drivers for your computer. <p>NOTE: Drivers and documentation updates can be found at support.dell.com.</p> <ul style="list-style-type: none"> • Desktop System Software (DSS). • Readme files. <p>NOTE: Readme files may be included on your media to provide last-minute updates about technical changes to your computer or advanced technical-reference material for technicians or experienced users.</p>
<p>Operating System Media</p> <p>The Operating System media is a CD or DVD that may have shipped with your computer.</p>	<p>Reinstall your operating system</p>
<p>Service Manual</p> <p>The <i>Service Manual</i> for your computer can be found at support.dell.com.</p>	<ul style="list-style-type: none"> • How to remove and replace parts • How to configure system settings • How to troubleshoot and solve problems

Document/Media/Label	Contents
<p>Dell Technology Guide</p> <p>The <i>Dell Technology Guide</i> is available at support.dell.com.</p>	<ul style="list-style-type: none"> • About your operating system. • Using and maintaining peripherals. • Understanding technologies such as RAID, Internet, Bluetooth[®], E-mail, networking, and more.
<p>Microsoft[®] Windows[®] License Label</p> <p>Your Microsoft Windows License is located on your computer.</p>	<ul style="list-style-type: none"> • Provides your operating system product key.
<p>Product safety and warranty information is available as a hardcopy with your computer.</p>	<ul style="list-style-type: none"> • Warranty information • Terms and Conditions (U.S. only) • Safety instructions • Regulatory information • Ergonomics information • End User License Agreement

Getting Help

Obtaining Assistance

 **CAUTION:** If you need to remove the computer cover, first disconnect the computer power and modem cables from all electrical outlets.

If you experience a problem with your computer, you can complete the following steps to diagnose and troubleshoot the problem:

- 1 See "Solving Problems" on page 35 for information and procedures that pertain to the problem your computer is experiencing.
- 2 See "Dell Diagnostics" on page 31 for procedures on how to run Dell Diagnostics.
- 3 Fill out the "Diagnostics Checklist" on page 56.
- 4 Use Dell's extensive suite of online services available at Dell Support (support.dell.com) for help with installation and troubleshooting procedures. See "Online Services" on page 52 for a more extensive list of Dell Support online.
- 5 If the preceding steps have not resolved the problem, see "Contacting Dell" on page 57.

 **NOTE:** Call Dell Support from a telephone near or at the computer so that the support staff can assist you with any necessary procedures.

 **NOTE:** Dell's Express Service Code system may not be available in all countries.

When prompted by Dell's automated telephone system, enter your Express Service Code to route the call directly to the proper support personnel. If you do not have an Express Service Code, open the **Dell Accessories** folder, double-click the **Express Service Code** icon, and follow the directions.

For instructions on using the Dell Support, see "Technical Support and Customer Service" on page 52.



NOTE: Some of the following services are not always available in all locations outside the continental U.S. Call your local Dell representative for information on availability.

Technical Support and Customer Service

Dell's support service is available to answer your questions about Dell™ hardware. Our support staff uses computer-based diagnostics to provide fast, accurate answers.

To contact Dell's support service, see "Before You Call" on page 55, and then see the contact information for your region or go to support.dell.com.

DellConnect™

DellConnect is a simple online access tool that allows a Dell service and support associate to access your computer through a broadband connection, diagnose your problem and repair it all under your supervision. For more information, go to support.dell.com and click **DellConnect**.

Online Services

You can learn about Dell products and services on the following websites:

www.dell.com

www.dell.com/ap (Asian/Pacific countries only)

www.dell.com/jp (Japan only)

www.euro.dell.com (Europe only)

www.dell.com/la (Latin American and Caribbean countries)

www.dell.ca (Canada only)

You can access Dell Support through the following websites and e-mail addresses:

- Dell Support websites
support.dell.com
support.jp.dell.com (Japan only)
support.euro.dell.com (Europe only)

- Dell Support e-mail addresses
mobile_support@us.dell.com
support@us.dell.com
la-techsupport@dell.com (Latin America and Caribbean countries only)
apsupport@dell.com (Asian/Pacific countries only)
- Dell Marketing and Sales e-mail addresses
apmarketing@dell.com (Asian/Pacific countries only)
sales_canada@dell.com (Canada only)
- Anonymous file transfer protocol (FTP)
ftp.dell.com
Log in as user: anonymous, and use your e-mail address as your password.

AutoTech Service

Dell's automated support service—AutoTech—provides recorded answers to the questions most frequently asked by Dell customers about their portable and desktop computers.

When you call AutoTech, use your touch-tone telephone to select the subjects that correspond to your questions. For the telephone number to call for your region, see "Contacting Dell" on page 57.

Automated Order-Status Service

To check on the status of any Dell products that you have ordered, you can go to support.dell.com, or you can call the automated order-status service. A recording prompts you for the information needed to locate and report on your order. For the telephone number to call for your region, see "Contacting Dell" on page 57.

Problems With Your Order

If you have a problem with your order, such as missing parts, wrong parts, or incorrect billing, contact Dell for customer assistance. Have your invoice or packing slip handy when you call. For the telephone number to call for your region, see "Contacting Dell" on page 57.

Product Information

If you need information about additional products available from Dell, or if you would like to place an order, visit the Dell website at www.dell.com. For the telephone number to call for your region or to speak to a sales specialist, see "Contacting Dell" on page 57.

Returning Items for Warranty Repair or Credit

Prepare all items being returned, whether for repair or credit, as follows:

- 1** Call Dell to obtain a Return Material Authorization Number, and write it clearly and prominently on the outside of the box.

For the telephone number to call for your region, see "Contacting Dell" on page 57. Include a copy of the invoice and a letter describing the reason for the return.

- 2** Include a copy of the Diagnostics Checklist (see "Diagnostics Checklist" on page 56), indicating the tests that you have run and any error messages reported by the Dell Diagnostics (see "Contacting Dell" on page 57).
- 3** Include any accessories that belong with the item(s) being returned (power cables, software floppy disks, guides, and so on) if the return is for credit.
- 4** Pack the equipment to be returned in the original (or equivalent) packing materials.

You are responsible for paying shipping expenses. You are also responsible for insuring any product returned, and you assume the risk of loss during shipment to Dell. Collect On Delivery (C.O.D.) packages are not accepted.

Returns that are missing any of the preceding requirements will be refused at Dell's receiving dock and returned to you.

Before You Call



NOTE: Have your Express Service Code ready when you call. The code helps Dell's automated-support telephone system direct your call more efficiently. You may also be asked for your Service Tag (located on the back or bottom of your computer).

Remember to fill out the Diagnostics Checklist (see "Diagnostics Checklist" on page 56). If possible, turn on your computer before you call Dell for assistance and call from a telephone at or near the computer. You may be asked to type some commands at the keyboard, relay detailed information during operations, or try other troubleshooting steps possible only at the computer itself. Ensure that the computer documentation is available.



CAUTION: Before working inside your computer, follow the safety instructions that shipped with your computer.

Diagnostics Checklist

Name:

Date:

Address:

Phone number:

Service Tag:

Express Service Code:

Return Material Authorization Number (if provided by Dell support technician):

Operating system and version:

Devices:

Expansion cards:

Are you connected to a network? Yes No

Network, version, and network adapter:

Programs and versions:

See your operating system documentation to determine the contents of the system's start-up files. If the computer is connected to a printer, print each file. Otherwise, record the contents of each file before calling Dell.

Error message, beep code, or diagnostic code:

Description of problem and troubleshooting procedures you performed:

Contacting Dell

For customers in the United States, call 800-WWW-DELL (800-999-3355).



NOTE: If you do not have an active Internet connection, you can find contact information on your purchase invoice, packing slip, bill, or Dell product catalog.

Dell provides several online and telephone-based support and service options. Availability varies by country and product, and some services may not be available in your area. To contact Dell for sales, technical support, or customer service issues:

- 1 Visit support.dell.com.
- 2 Verify your country or region in the **Choose A Country/Region** drop-down menu at the bottom of the page.
- 3 Click **Contact Us** on the left side of the page.
- 4 Select the appropriate service or support link based on your need.
- 5 Choose the method of contacting Dell that is convenient for you.

Appendix

FCC Notice (U.S. Only)

FCC Class B

This equipment generates, uses, and can radiate radio frequency energy and, if not installed and used in accordance with the manufacturer's instruction manual, may cause interference with radio and television reception. This equipment has been tested and found to comply with the limits for a Class B digital device pursuant to Part 15 of the FCC Rules.

This device complies with Part 15 of the FCC Rules. Operation is subject to the following two conditions:

- 1 This device may not cause harmful interference.
- 2 This device must accept any interference received, including interference that may cause undesired operation.



NOTICE: The FCC regulations provide that changes or modifications not expressly approved by Dell Inc. could void your authority to operate this equipment.

These limits are designed to provide reasonable protection against harmful interference in a residential installation. However, there is no guarantee that interference will not occur in a particular installation. If this equipment does cause harmful interference with radio or television reception, which can be determined by turning the equipment off and on, you are encouraged to try to correct the interference by one or more of the following measures:

- Reorient the receiving antenna.
- Relocate the system with respect to the receiver.
- Move the system away from the receiver.
- Plug the system into a different outlet so that the system and the receiver are on different branch circuits.

If necessary, consult a representative of Dell Inc. or an experienced radio/television technician for additional suggestions.

The following information is provided on the device or devices covered in this document in compliance with the FCC regulations:

- Product name: Dell™ Inspiron 518/Dell Inspiron 519
- Model number: DCMF
- Company name:
Dell Inc.
Worldwide Regulatory Compliance & Environmental Affairs
One Dell Way
Round Rock, TX 78682 USA
512-338-4400



NOTE: For further regulatory information, see the regulatory information that shipped with your computer.

Macrovision Product Notice

This product incorporates copyright protection technology that is protected by method claims of certain U.S. patents and other intellectual property rights owned by Macrovision Corporation and other rights owners. Use of this copyright protection technology must be authorized by Macrovision Corporation, and is intended for home and other limited viewing uses only unless otherwise authorized by Macrovision Corporation. Reverse engineering or disassembly is prohibited.

Index

B

beep codes, 27

C

CDs

operating system, 49

computer

beep codes, 27

crashes, 37-38

restore to previous state, 44

specifications, 17

stops responding, 37

conflicts

software and hardware
incompatibilities, 31

contacting Dell, 57

D

Dell

contacting, 57

Dell Diagnostics, 31

Dell Technology Guide, 50

DellConnect, 52

diagnostics

beep codes, 27

Dell, 31

documentation

Dell Technology Guide, 50

End User License Agreement, 50

ergonomics, 50

Product Information Guide, 50

regulatory, 50

safety, 50

Service Manual, 49

warranty, 50

drivers, 41

about, 41

identifying, 42

reinstalling, 42

Drivers and Utilities media

Dell Diagnostics, 31

E

End User License Agreement, 50

ergonomics information, 50

error messages

beep codes, 27

F

Factory Image Restore, 46

Files and Settings Transfer

Wizard, 15

H

hardware

- beep codes, 27
- conflicts, 31
- Dell Diagnostics, 31

I

Internet connection

- about, 13
- options, 13
- setting up, 13

IRQ conflicts, 31

M

memory

- problems, 36

O

operating system

- media, 47
- reinstalling, 49

Operating System CD, 49

P

phone numbers, 57

power

- problems, 35

power light

conditions, 35

printer

- connecting, 13
- setting up, 13

problems

- beep codes, 27
- blue screen, 38
- computer crashes, 37-38
- computer stops responding, 37
- conflicts, 31
- Dell Diagnostics, 31
- general, 37
- memory, 36
- power, 35
- power light conditions, 35
- program crashes, 38
- program stops responding, 38
- programs and Windows compatibility, 38
- restore to previous state, 44-45
- software, 38-39

Program Compatibility

Wizard, 38

R

regulatory information, 50

S

- S.M.A.R.T, 30
- safety instructions, 50
- Service Manual, 49
- software
 - conflicts, 31
 - problems, 38-39
- specifications, 17
- Starting the Dell Diagnostics
 - From the Drivers and Utilities CD, 32
- Starting the Dell Diagnostics From Your Hard Drive, 32
- support
 - contacting Dell, 57
- System Restore, 44-45

T

- telephone numbers, 57
- transferring information to a new computer, 15
- troubleshooting
 - conflicts, 31
 - Dell Diagnostics, 31
 - Hardware Troubleshooter, 31
 - restore to previous state, 44-45

W

- warranty information, 50

- Windows Vista
 - Factory Image Restore, 46
 - Hardware Troubleshooter, 31
 - Program Compatibility Wizard, 38
 - System Restore, 45
- Windows XP
 - Device Driver Rollback, 42
 - Files and Settings Transfer Wizard, 15
 - reinstalling, 49
 - System Restore, 44-45
- wizards
 - Files and Settings Transfer Wizard, 15
 - Program Compatibility Wizard, 38

